



ENAPART



93 S Railroad Avenue Unit C
Bergenfield NJ 07621 USA
www.enapart.com
sales@enapart.com



Via del Canneto 35,
Borgosatollo, Brescia - Italia
www.enapart.it
vendite@enapart.it



Barbaros Mah. Ihlamur Bul. Aĝaoĝlu
My Newwork No:3/15 Ataşehir / İstanbul
www.enapart.net
satis@enapart.net



PRIVADA 10 B SUR #3908 COL.
ANZUREZ, C.P. 72530, PUEBLA, PUE
www.enapart.com.mx
sales@enapart.com.mx



Friedrich-Ebert-Anlage 36, 60325
Frankfurt am Main, Germany
www.enapart.de
anfrage@enapart.de



4 boulevard Carnot, 95400
villiers-le-bel, Paris, France
www.enapart.fr
sales@enapart.fr



65049, ОДЕСА, ВУЛИЦЯ ІВАНА
ФРАНКА, БУДИНОК 55, ПОВЕРХ 3
www.enapart.com.ua
sales@enapart.com.ua



MUNICIPIUL BUCUREȘTI, SECTOR 3,
B-DUL BASARABIA, NR.250, CORP P+5
www.enapart.ro
sales@enapart.ro



〒584-0023 大阪府富田林市若松町
東2丁目2番16号
www.enapart.co.jp
sales@enapart.co.jp



PLAZA NUESTRA SEÑORA DE LAS
NIEVES 12 ,LOCAL ,50012,ZARAGOZA
www.enapart.es
ventas@enapart.es



Складова база „Онџл“, Склад А2, п.к.
4006, гр. Пловдив, България
www.enapart.bg
sales@enapart.bg



3 Austin Mews, High Street, Hemel
Hempstead, HP1 3AF , United Kingdom
www.enapart.co.uk
sales@enapart.co.uk



CAD drawing data catalog
is available.

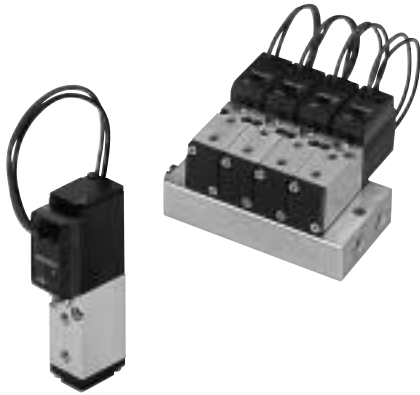

KOGANEI

VALVES GENERAL CATALOG

SOLENOID VALVES 010 SERIES

SOLENOID VALVES 010 SERIES INDEX

| | |
|---------------------------------------|----|
| Features | 61 |
| Basic Models and Configuration | 62 |
| Specifications | 63 |
| Solenoid Valve/Manifold Order Code | 65 |
| Operating Principle and Symbol | 66 |
| Dimensions of Solenoid Valve | 67 |
| Dimensions of Manifold | 69 |
| Handling Instructions and Precautions | 71 |



Caution

Before use, be sure to read the "Safety Precautions" on p. 31.

POWERFUL & LOW POWER CONSUMPTION

SOLENOID VALVES 010 SERIES

The Solenoid Valves 010 series achieves high reliability, powerful action, and low current with a thin-body 10mm [0.394in.] valve width.

All of these highly reliable 5-port valves incorporate flywheel diodes for surge suppression as a standard feature, to ensure highly reliable operation.

Capable of mounting valves on the manifolds for up to 20 units, this series is the optimum response to customers' requirements for both economy and diversity, enabling operation for double acting cylinders up to ϕ 16 [0.630in.] bore.

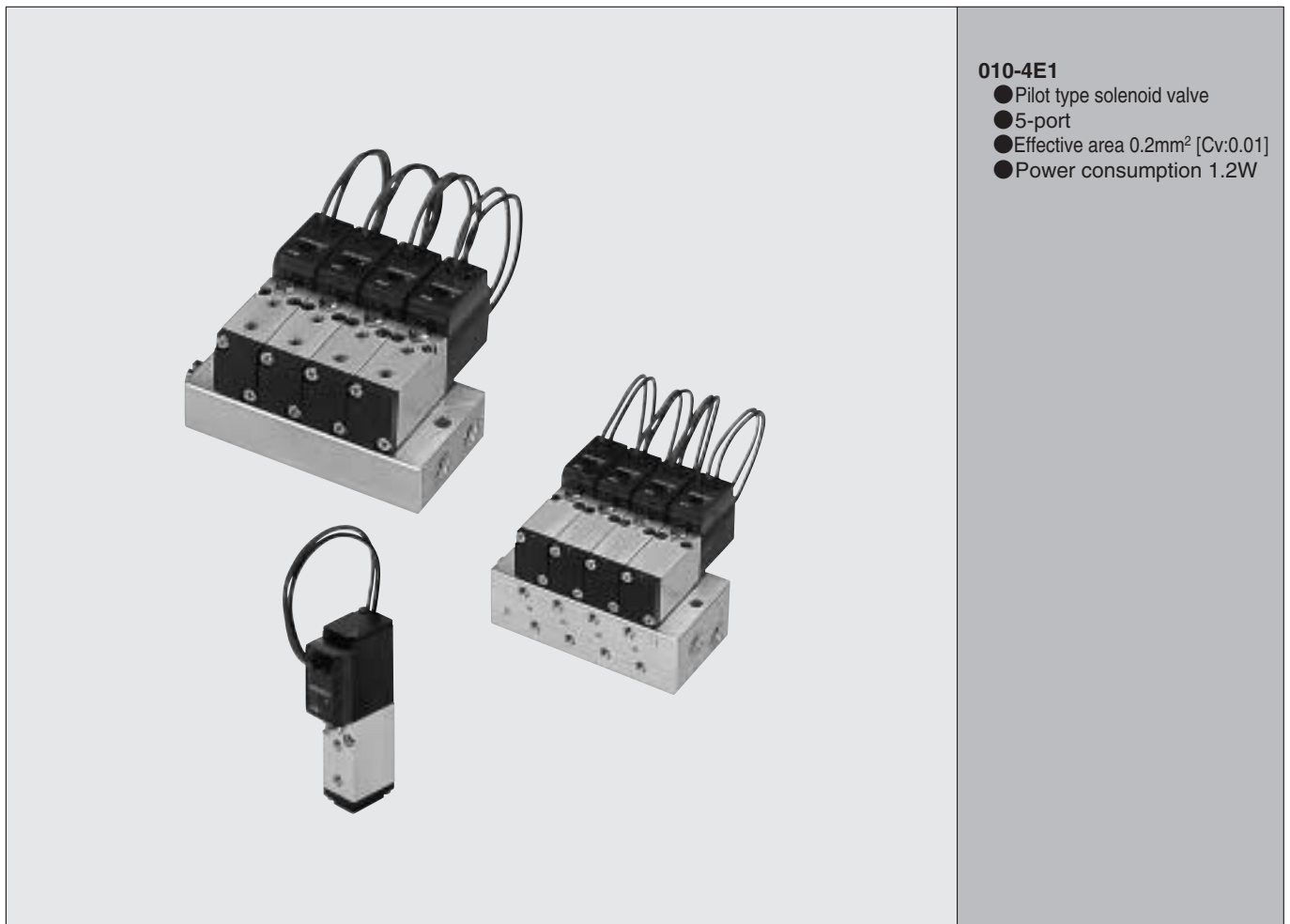



010-4E1

- Pilot type solenoid valve
- 5-port
- Effective area 0.2mm² [Cv:0.01]
- Power consumption 1.2W

Basic Models and Configuration

Single unit

| Pilot type solenoid valve | |
|---------------------------|--|
| 010-4E1 | |
| 5-port | |
| Direct piping |  <p>Single solenoid</p> <p>010-4E1</p> |
| Sub-base piping |  <p>Single solenoid</p> <p>A010-4E1-25</p> |

SOLENOID VALVES 010 SERIES

Manifold

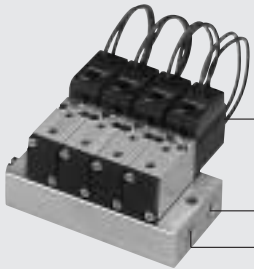
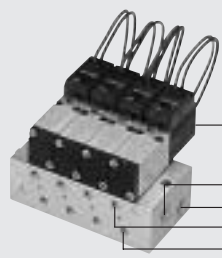
| 010-4E1 | |
|--|---|
| Small sized manifold for 5-port valves | <div style="display: flex; justify-content: space-around;"> <div style="text-align: center;"> <p>010MB□F—F type (P, R) manifold</p>  <p>010-4E1</p> <p>1(P)</p> <p>3, 5(R)</p> </div> <div style="text-align: center;"> <p>010MB□A—A type (all port) manifold</p>  <p>A010-4E1</p> <p>3, 5(R)</p> <p>1(P)</p> <p>2(B)</p> <p>4(A)</p> </div> </div> |

SOLENOID VALVES

010 SERIES

Basic Models and Valve Functions

| Item | Basic model | Direct piping, F type manifold | Sub-base piping, A type manifold |
|---------------------|-------------|--------------------------------|----------------------------------|
| | | 010-4E1 | A010-4E1 ^{Note} |
| Number of positions | | 2 positions | |
| Number of ports | | 5 ports | |
| Valve function | | Single solenoid | |

Remark: For optional specifications and order code, see p.65.

Note: A010-4E1, except one with a sub-base, is for A type manifolds only. It cannot be used as a single unit.

Specifications

| Item | Basic model | Direct piping, F type manifold | Sub-base piping, A type manifold |
|--|-----------------------------------|---|-----------------------------------|
| | | 010-4E1 | A010-4E1 |
| Media | | Air | |
| Operation type | | Internal pilot type | |
| Effective area [Cv] ^{Note1} | mm ² | 1(P)→4(A) 0.2 [0.01] | 4(A)→5(R1), 2(B)→3(R2) 0.3 [0.02] |
| Port size ^{Note2} | | M3×0.5 | |
| Lubrication | | Not required | |
| Operating pressure range | MPa {kgf/cm ² } [psi.] | 0.15~0.7 {1.5~7.1} [22~102] | |
| Proof pressure | MPa {kgf/cm ² } [psi.] | 1.05 {10.7} [152] | |
| Response time ^{Note3} | ms | DC5V, DC12V | 4/8 or below |
| ON/OFF | | DC6V, DC24V | 4/8 or below |
| Maximum operating frequency | Hz | 5 | |
| Minimum time to energize for self holding | ms | — | |
| Operating temperature range (atmosphere and media) | °C [°F] | 5~50 [41~122] | |
| Shock resistance | m/s ² {G} | 1373.0 {140.0} (Axial direction 392.3 {40.0}) | |
| Mounting direction | | Any | |

Notes: 1. For details, see the effective area on p.64.

2. For details, see the port size on p.64.

3. Values when air pressure is 0.5MPa {5.1kgf/cm²} [73psi.].

Solenoid Specifications

| Item | Rated voltage | DC5V | DC6V | DC12V | DC24V |
|---|---------------|------------------------|---|------------------------|----------------------|
| | Type | | With built-in flywheel diodes for surge suppression | | |
| Operating voltage range | DC V | 4.5~5.5 (5±10%) | 5.4~6.6 (6±10%) | 10.8~13.2 (12±10%) | 21.6~26.4 (24±10%) |
| Current (Power consumption when rated voltage is applied) | mA (W) | 246 (1.2) | 201 (1.2) | 103 (1.2) | 52 (1.2) |
| Maximum allowable leakage current | mA | 30 | 25 | 15 | 5 |
| Insulation resistance | MΩ | Over 100 | | | |
| Wiring type ^{Note} | Standard | Grommet type | | | |
| | Optional | Plug connector type | | | |
| Lead wire length ^{Note} | | 300 mm [11.8in.] | | | |
| Color of lead wire | | Green (+) Black (-) | Blue (+) Black (-) | Brown (+) Black (-) | Red (+) Black (-) |
| Color of LED indicator | | Red | | | |
| Surge suppression (as standard) | | Flywheel diode | | | |

Note: See made to order on p.65.

Flow Rate

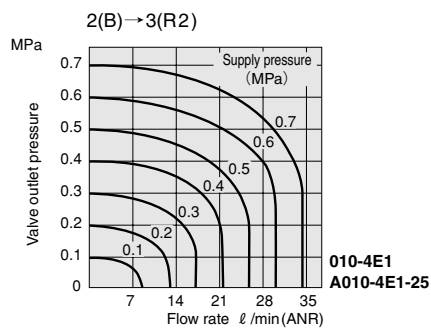
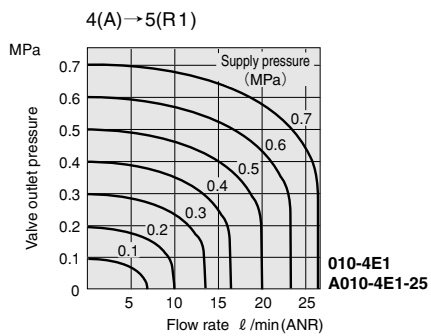
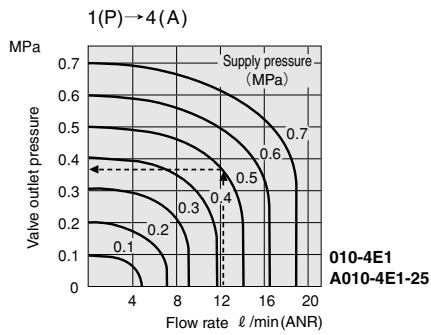

1MPa = 145psi., 1 l /min = 0.0353ft.³/min

How to read the graph (For 1(P)→4(A))

When the supply pressure is 0.5MPa [73psi.] and flow rate is 12 l /min [0.42ft.³/min] (ANR), the valve outlet pressure becomes 0.36MPa [52psi.].

Effective Area [Cv]

mm²

| Basic model | Standard (Single valve) | Remarks |
|-----------------|--|---|
| 010-4E1 | 1(P)→4(A) 0.2 [0.01] 4(A)→5(R1) 0.3 [0.02] 2(B)→3(R2) 0.4 [0.02] | <ul style="list-style-type: none"> ● For the case with quick fitting TSH4-M3M attached to the 1(P), 4(A), and 2(B) ports. ● Same values as for the case with quick fitting TSH4-M3M attached to the 4(A) port on F type manifold. |
| A010-4E1 | 1(P)→4(A) 0.2 [0.01] 4(A)→5(R1) 0.3 [0.02] 2(B)→3(R2) 0.4 [0.02] | <ul style="list-style-type: none"> ● For the case with quick fitting TSH4-M5M attached to the 1(P) port and quick fitting TSH4-M3M attached to the 4(A) port on A type manifold. |

Solenoid Valve Mass

g [oz.]

| Basic model | Mass |
|-----------------|-----------------------|
| 010-4E1 | 20 [0.71] |
| A010-4E1 | 20 [0.71] (38 [1.34]) |

Remark: Figures in parentheses () are the mass with sub-base: -25.

Manifold Mass

g [oz.]

| Manifold model | Mass calculation of each unit (n=number of units) | Block-off plate |
|----------------|---|-----------------|
| 010MB□F | (8.5×n)+13 [(0.300×n)+0.46] | 3 [0.11] |
| 010MB□A | (13.5×n)+15 [(0.476×n)+0.53] | 3 [0.11] |

Solenoid Valve Port Size

| Basic model | Port | Port specification | Port size |
|--------------------------------|------------------|--------------------|-----------|
| 010-4E1 ^{Note} | 1(P), 4(A), 2(B) | Female thread | M3×0.5 |
| A010-4E1-25 | 1(P) | Female thread | M5×0.8 |
| | 4(A), 2(B) | Female thread | M3×0.5 |
| | 3, 5(R) | Female thread | M5×0.8 |

Note: The 3(R2) and 5(R1) ports are 1.2mm diameter holes, not to be used for connecting.

Manifold Port Size

| Manifold model | Port | Location of piping port | Port size |
|----------------|------------|-------------------------|-----------|
| 010MB□F | 1(P) | Manifold | M5×0.8 |
| | 4(A), 2(B) | Valve | M3×0.5 |
| | 3, 5(R) | Manifold | M5×0.8 |
| 010MB□A | 1(P) | Manifold | M5×0.8 |
| | 4(A), 2(B) | | M3×0.5 |
| | 3, 5(R) | | M5×0.8 |

010 Series Solenoid Valve Order Code

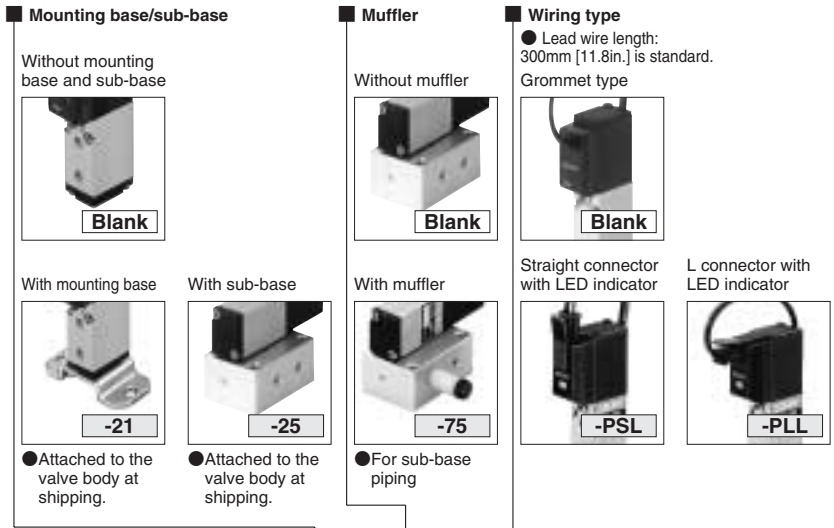

Solenoid Valve Order Code

| | | Basic model | | | Voltage |
|-----------------|------------------------|---------------------------------|---------|------|--------------|
| Direct piping | 5-port single solenoid | 010-4E1 | -21 | -PSL | DC5V, DC6V |
| Sub-base piping | 5-port single solenoid | A010-4E1 ^{Note} | -25 -75 | -PLL | DC12V, DC24V |

Note : Cannot be used as a single unit.

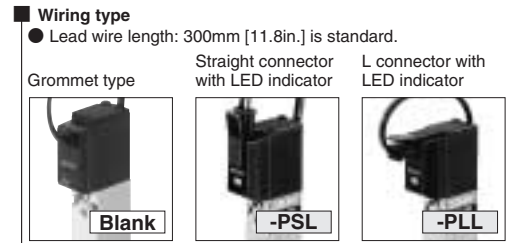

Manifold Order Code

| | | Manifold model Number of units | Station | Basic model | Voltage | | |
|------------------------|--------------|-----------------------------------|---------|---|-----------|--------------|----------------------------|
| 5-port single solenoid | 010MB | 2 ⋮ 20 | F | stn. <input type="checkbox"/> ⋮ stn. <input type="checkbox"/> | -010-4E1 | -PSL -PLL | DC5V, DC6V DC12V, DC24V |
| | | | A | | -A010-4E1 | | |

● Valve mounting location from the left-hand side when facing the 4(A), 2(B) ports. (□ : 1~20)

● Specify the valve type for each station.
● Enter -BP when closing a station with a block-off plate without mounting a valve.

Additional Parts (To be ordered separately)



● For sub-base piping



● **010** MB **F** -BP
 F— For F type manifold
 A— For A type manifold
 010—For 010M

Made to Order



● For plug connector

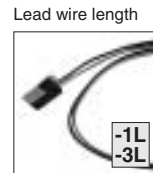

● Length -1L: 1000 [39in.] (mm)
 ● -3L: 3000 [118in.]



● For 010-4E1, A010-4E1

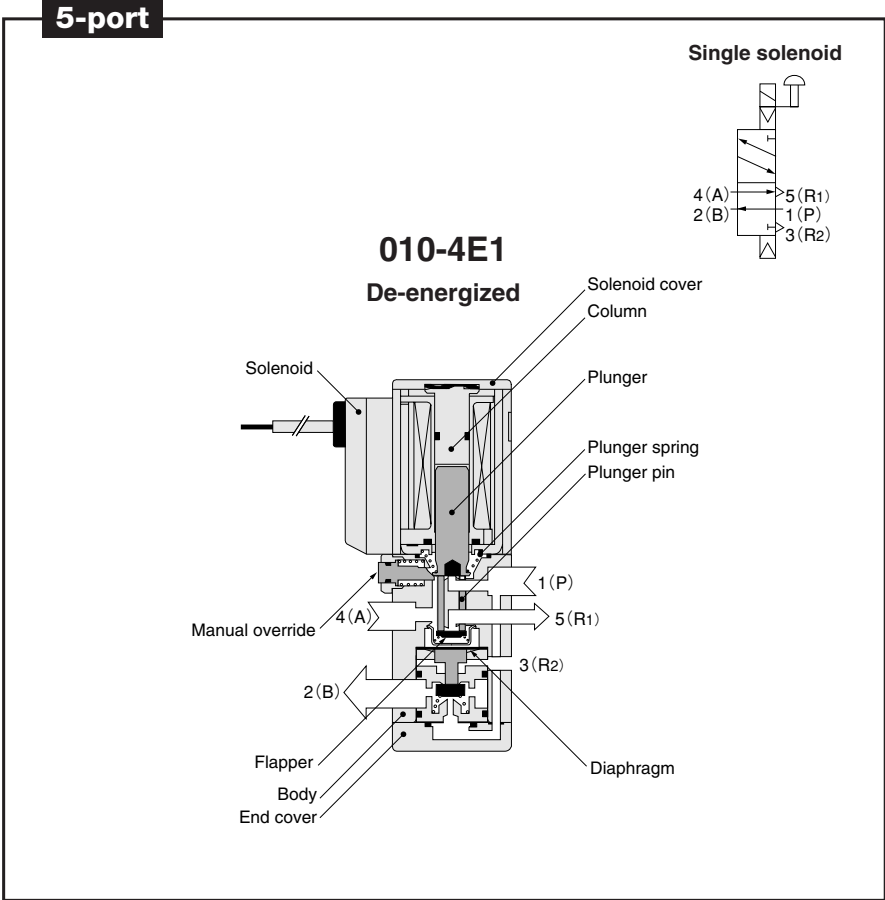

Major Parts and Materials

| | Parts | Materials |
|----------|-------------------|---------------------------|
| Valve | Body | Aluminum alloy (anodized) |
| | Stem | Aluminum alloy (anodized) |
| | Flapper | Synthetic rubber |
| | Mounting base | Steel (zinc plated) |
| | Sub-base | Aluminum alloy (anodized) |
| | Plunger Column | Magnetic stainless steel |
| Manifold | Body | Aluminum alloy (anodized) |
| | Block-off plate | Steel (nickel plated) |
| | Seal | Synthetic rubber |

Dimensions of Solenoid Valve (mm)

010-4E1



A010-4E1-25

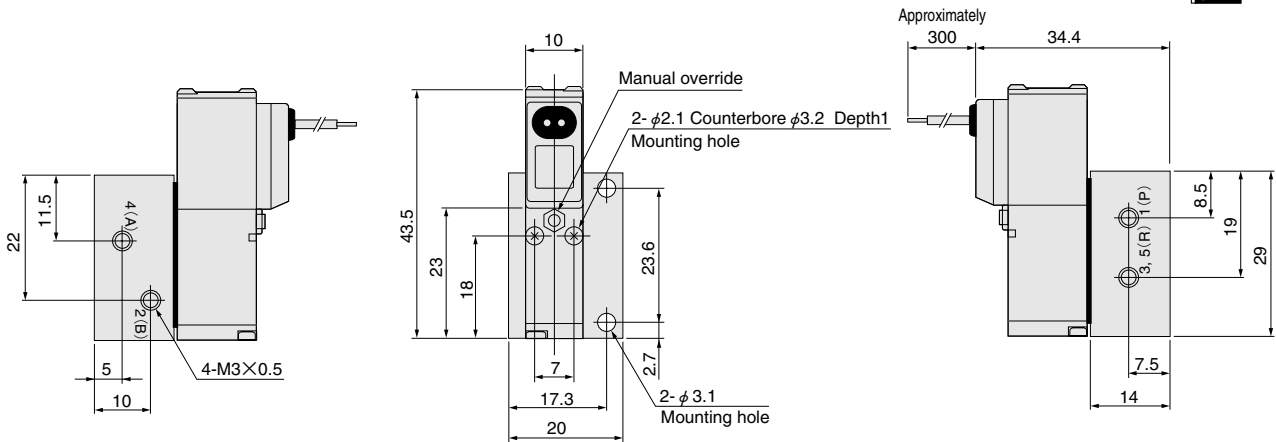

Options

● Mounting base: **-21**

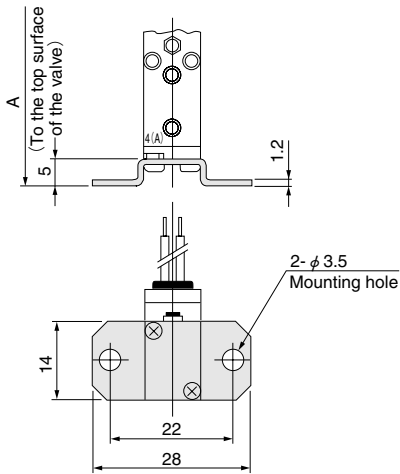

● Solenoid with straight connector: **-PSL**

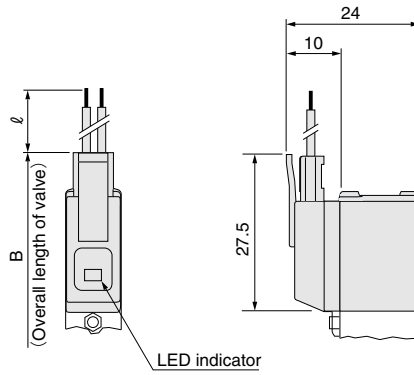

● Muffler: **-75**
(Only for A010-4E1-25)

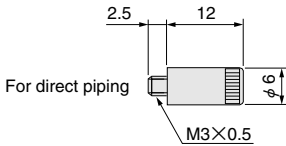
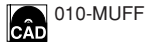

● Solenoid with L connector: **-PLL**

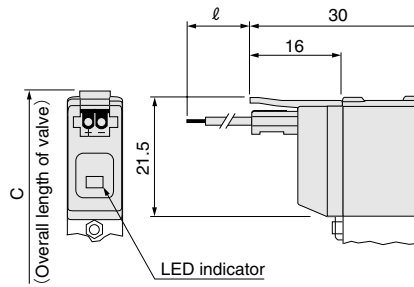

| Model | Code | A | B | C | D |
|---------|------|------|------|------|------|
| 010-4E1 | | 48.5 | 50.5 | 44.5 | 43.5 |

Made to Order

● Locking protruding type manual override: **-83**

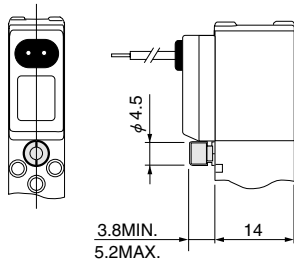
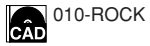

● Grommet type with LED indicator: **-L**

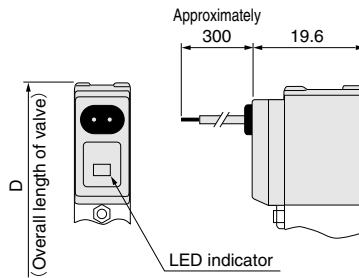

| Model | Code | ℓ (Lead wire length) |
|----------------|-------------------|----------------------|
| -PSL, -PLL, -L | (standard length) | 300 |
| Made to order | -1L | 1000 |
| | -3L | 3000 |

Dimensions of Manifold (mm)

010MB□F

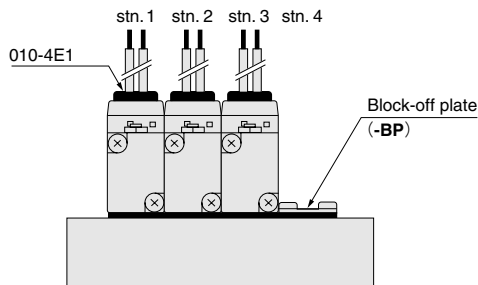
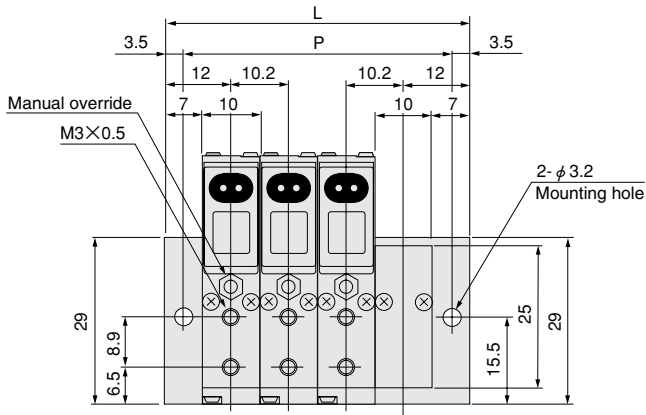

Unit dimensions

| Model | P | L | Model | P | L |
|---------|-------|-------|----------|-------|-------|
| 010MB2F | 27.2 | 34.2 | 010MB12F | 129.2 | 136.2 |
| 3F | 37.4 | 44.4 | 13F | 139.4 | 146.4 |
| 4F | 47.6 | 54.6 | 14F | 149.6 | 156.6 |
| 5F | 57.8 | 64.8 | 15F | 159.8 | 166.8 |
| 6F | 68.0 | 75.0 | 16F | 170.0 | 177.0 |
| 7F | 78.2 | 85.2 | 17F | 180.2 | 187.2 |
| 8F | 88.4 | 95.4 | 18F | 190.4 | 197.4 |
| 9F | 98.6 | 105.6 | 19F | 200.6 | 207.6 |
| 10F | 108.8 | 115.8 | 20F | 210.8 | 217.8 |
| 11F | 119.0 | 126.0 | — | — | — |

For wiring options and made to order, see p.68.

Dimensions of Manifold (mm)

010MB□A



SOLENOID VALVES 010 SERIES

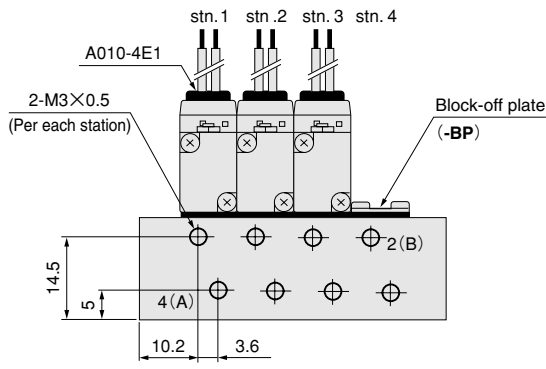
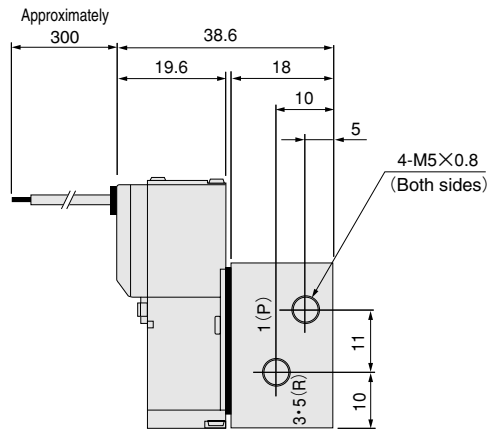

Unit dimensions

| Model | P | L | Model | P | L |
|---------|-------|-------|----------|-------|-------|
| 010MB2A | 27.2 | 34.2 | 010MB12A | 129.2 | 136.2 |
| 3A | 37.4 | 44.4 | 13A | 139.4 | 146.4 |
| 4A | 47.6 | 54.6 | 14A | 149.6 | 156.6 |
| 5A | 57.8 | 64.8 | 15A | 159.8 | 166.8 |
| 6A | 68.0 | 75.0 | 16A | 170.0 | 177.0 |
| 7A | 78.2 | 85.2 | 17A | 180.2 | 187.2 |
| 8A | 88.4 | 95.4 | 18A | 190.4 | 197.4 |
| 9A | 98.6 | 105.6 | 19A | 200.6 | 207.6 |
| 10A | 108.8 | 115.8 | 20A | 210.8 | 217.8 |
| 11A | 119.0 | 126.0 | — | — | — |

For wiring options and made to order, see p.68.

Handling Instructions and Precautions



Solenoid

Internal circuit

● DC5V, DC6V, DC12V, DC24V

Standard solenoid (Surge suppression)

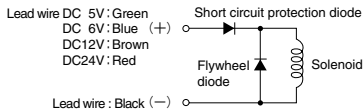

Solenoid with LED indicator (Surge suppression)

Order code: -PSL, -PLL

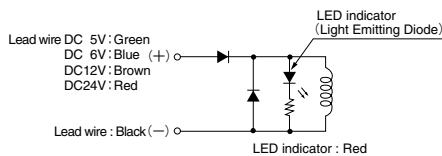

- Cautions:**
1. Do not apply megger between the lead wires.
 2. The DC solenoid will not short circuit even if the wrong polarity is applied, but the valve will not operate.
 3. Leakage current inside the circuit could result in failure of the solenoid valve to return, or in other erratic operation. Always use it within the range of the allowable leakage current. If circuit conditions, etc. cause the leakage current to exceed the maximum allowable leakage current, consult us.



Plug connector

Attaching and removing plug connector

Use fingers to insert the connector into the pin, push it in until the lever claw latches onto the protruded section of the connector housing, and complete the connection.

To remove the connector, squeeze the lever along with the connector, lift the lever claw up from the protruded section of the connector housing, and pull it out.

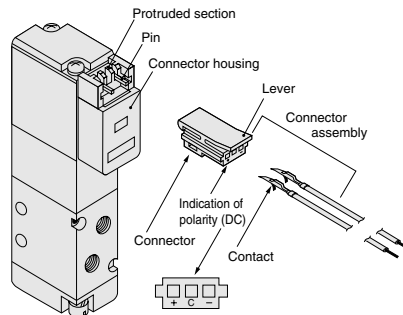

※ Illustration shows the 110 series.

Crimping of connecting lead wire and contact

To crimp lead wires into contacts, strip off 4mm [0.16in.] of the insulation from the end of the lead wire, insert it into the contact, and crimp it. Be sure to avoid catching the insulation on the exposed wire crimping section.

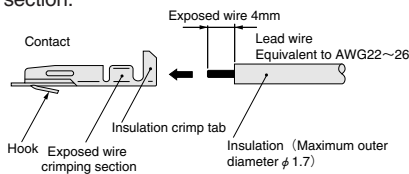

- Cautions:**
1. Do not pull hard on the lead wire.
 2. Always use a dedicated tool for crimping of connecting lead wire and contact.
Contact: Model 702062-2M
Manufactured by Sumiko Tech, Inc.
Crimping tool: Model F1-702062
Manufactured by Sumiko Tech, Inc.

Attaching and removing contact and connector

Insert the contact with lead wire into a plug connector □ hole until the contact hook latches on and is secured to the plug connector. Confirm that the lead wire cannot be easily pulled out.

To remove it, insert a tool with a fine tip (such as a small screwdriver) into the rectangular hole on the side of the plug connector to push up on the hook, and then pull out the lead wire.

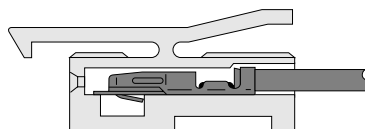

- Cautions:**
1. Do not pull hard on the lead wire. It could result in defective contacts, breaking wires, etc.
 2. If the pin is bent, use a small screwdriver, etc. to gently straighten out the pin, and then complete the connection to the plug connector.



Manual override

Non-locking type

To operate the manual override, press it all the way down. The valve works the same as in an energized state as long as the manual override is pushed down, and returns to the rest position upon release.

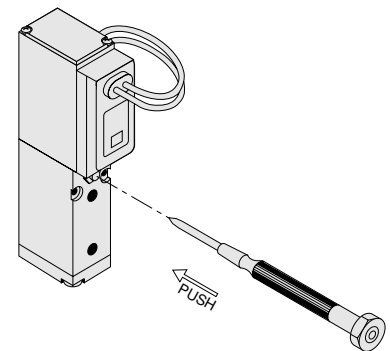

Locking protruding type

Use a small screwdriver to turn the adjusting knob several times in the clockwise direction, and lock the manual override in place. When locked, turning the adjusting knob several times in the counterclockwise direction releases a spring on the manual override, returns it to the original position, and releases the lock.

For the locking protruding type, when the adjusting knob is not turned, this type acts just like the non-locking type, the valve is energized as long as the manual override is pushed down, and it returns to the rest position upon release.

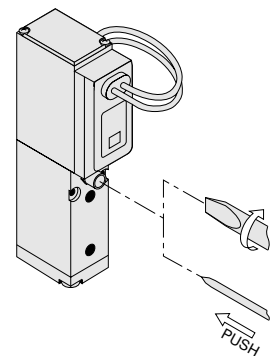

- Cautions:**
1. The 010 series valves are internal pilot type solenoid valves. As a result, the manual override cannot switch the main valve without air supplied from the 1(P) port.
 2. Always release the lock of the locking protruding type manual override before commencing normal operation.
 3. Do not attempt to operate the manual override with a pin or other object having an extremely fine tip. It could damage the manual override button.
 4. Do not turn the adjusting knob more than needed. It could result in defective operation.

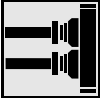

Fittings

Recommended fittings

010-4E1

| Parts | | Connection port | |
|-------------------------|-------------------|--------------------------------|--------------------------------|
| | | 4(A), 2(B) port | 1(P) port |
| Quick fitting | | TS3-M3M TL3-M3M TLL3-M3M | TS3-M3M TL3-M3M TLL3-M3M |
| TAC fitting | For urethane tube | BF4BU-M3 BF3BU-M3 | BF4BU-M3 BF3BU-M3 |
| | For nylon tube | BF4-M3 BF3.2-M3 | BF4-M3 BF3.2-M3 |
| Muffler (for reference) | | — | — |

A010-4E1-25

| Parts | | Connection port | | |
|-------------------------|--|--------------------------------|--------------------------------|--------------------------------|
| | | 4(A), 2(B) port | 1(P) port | 3, 5(R) port |
| Quick fitting | | TS3-M3M TS4-M3M TSH4-M3M | TS3-M3M TS4-M3M TSH4-M3M | TS3-M3M TS4-M3M TSH4-M3M |
| Muffler (for reference) | | — | — | KM-03 |

